

Dummy Covering

FEATURES:

Simple assembly

Snaps-in after assembly

SPECIFICATION:

Material PA66, UL-94V-2

Colour Black

Hole Diameter 6.4 mm

Panel Depth 7.9 mm

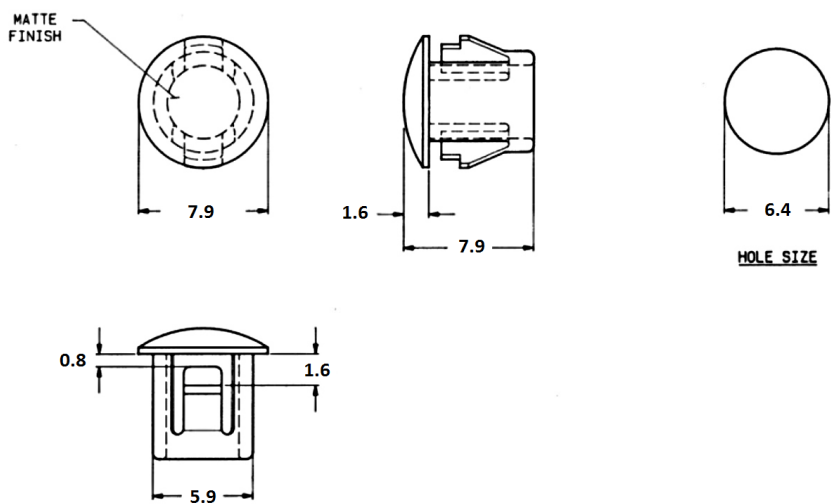

Art. Nr.

RND 610-00338